

Circulation pressure control and relief regulator VAR

TECHNICAL INFORMATION

- Circulation pressure control and relief regulator for gaseous media in all types of gas appliances
- High flow rate due to optimal dimensioning
- No purge line required
- Internal impulse



Contents

Contents	2
1 Application	3
1.1 Application examples	3
1.1.1 Gas booster system	3
2 Certification	5
3 Function	6
4 Flow rate	7
4.1 Calculating the nominal size	8
5 Selection	9
5.1 ProFi	9
5.2 Type code	9
6 Project planning information	10
6.1 Installation	10
7 Technical data	12
7.1 Spring table	12
7.2 Dimensions	13
8 Maintenance cycles	14
Fore more information	15

1 Application



VAR..R



VAR..F

Relief regulator VAR is suitable for maintaining constant pressures in gas appliances or for relieving brief pressure surges in control systems. By using the VAR, inadmissibly high pressures in vessels can be prevented.

Compressors and fans generate different outlet pressures in the case of different capacity demands. These fluctua-

tions can be controlled by discharging a bypass flow from the outlet to the inlet of the compressor unit. Downstream consumers thus dispose of constant pressure over the entire capacity range.

1.1 Application examples

1.1.1 Gas booster system



Industrial thermoprocessing equipment or combined heating and power plants in which the supply pressure is too low must be fitted with gas pressure boosters. The speed of the compressor and thereby the change in the outlet pressure or flow rate is controlled by a frequency converter. The frequency-controlled compressor allows a high turn-down. The control system includes the safety interlocks (limits) with temperature and pressure monitoring.

The gas pressure boosters are designed for an operating pressure of up to 1 bar and an output capacity of max. 50 kW in accordance with DVGW Code of Practice G 620.

Application

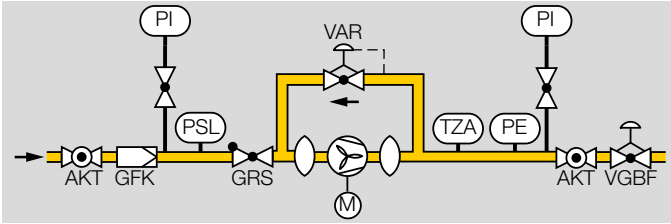

Gas pressure booster flowchart

If the pressure downstream of the fan is too high, circulation pressure control regulator VAR opens and routes the medium back to the inlet area.

2 Certification

The regulator complies with the essential health and safety requirements of the corresponding chapters in Annex 2 of the Machinery Directive 2006/42/EC in conjunction with EN 13611.

Approval for Russia



Certified by Gosstandart pursuant to GOST-TR.

Approved by Rostekhnadzor (RTN).

Scan of the approval for Russia (RUS) – see www.docuthek.com

3 Function

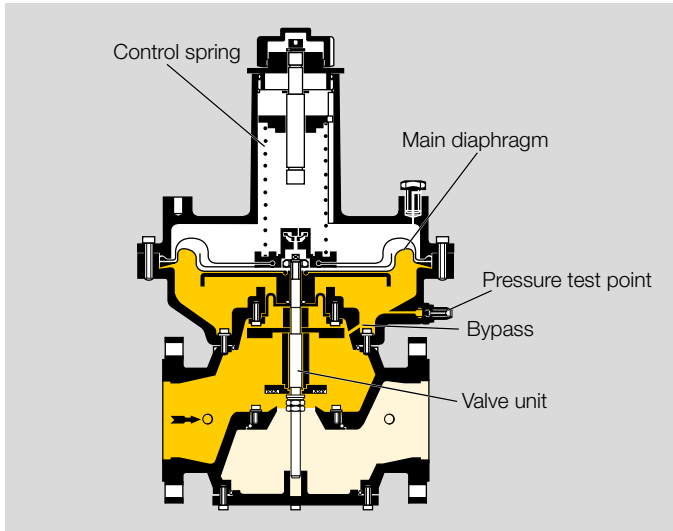

Circulation pressure control and relief regulator VAR is closed by a spring when no pressure is applied.

The gas flows from the inlet side into the space under the working diaphragm via the internal impulse bore. If the inlet pressure reaches the pressure set by the control spring, the diaphragm raises the valve unit. Regulator VAR opens and the gas can flow to the outlet.

If the inlet pressure has decreased due to the gas flowing out, the regulator closes.

A test nipple has been installed to measure the opening pressure p_{as} .

4 Flow rate

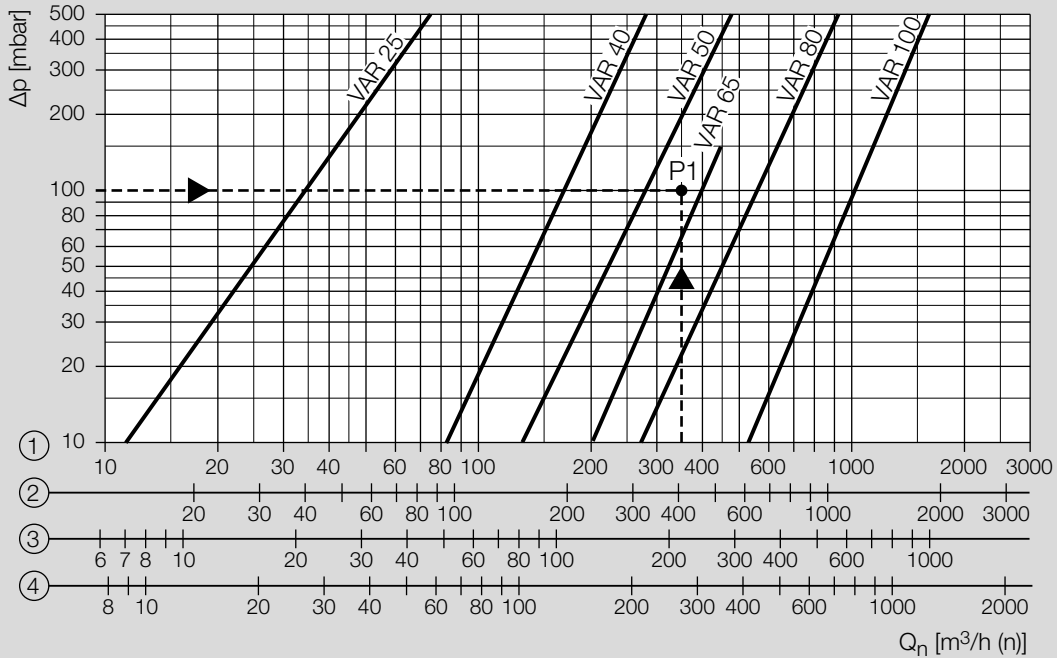

- 1 = natural gas ($\rho = 0.80 \text{ kg/m}^3$)
- 2 = town gas ($\rho = 0.58 \text{ kg/m}^3$)
- 3 = propane ($\rho = 2.01 \text{ kg/m}^3$)
- 4 = air ($\rho = 1.29 \text{ kg/m}^3$)

Reading instructions: should operating cubic metres (Q_b) have been used in the flow rate diagram, instead of standard cubic metres (Q_n), then the pressure loss read (Δp) must be multiplied by the absolute inlet pressure in bar (1 + positive pressure in bar).

Example: a circulation pressure control regulator should keep the outlet pressure of a gas pressure booster constant.

Medium: natural gas

Flow rate $Q = 350 \text{ m}^3/\text{h(n)}$

Opening pressure $p_{as} = 120 \text{ mbar}$

System inlet pressure: $p_{counter} = 20 \text{ mbar}$

The natural gas is discharged against the inlet pressure $p_{counter}$ of the system.

$$\Delta p = p_d - p_{\text{counter}}$$

$$\Delta p = 120 \text{ mbar} - 20 \text{ mbar} = 100 \text{ mbar}$$

The result is intersection P1 in the flow rate diagram. The next largest regulator must be selected: VAR 65.

4.1 Calculating the nominal size

A web app selecting the correct product is available at www.adlatus.org.

5 Selection

Option	VAR 25	VAR 40	VAR 50	VAR 65	VAR 80-100
DN	25	40	50	65	80, 100
Pipe connection	R	R, F	F	F	F
Inlet pressure	05	05	05	05	05
Opening pressure	-1, -2	-1, -2	-1, -2	-1	-1, -2
Special adjusting range	Z	Z	Z	Z	Z

Order example

VAR 40F05-2

5.1 ProFi

A web app selecting the correct product is available at www.adlatus.org.

5.2 Type code

VAR	Circulation pressure control and relief regulator
25-100	Nominal sizes
R	Rp internal thread
F	Flange to ISO 7005
05	p_u max. 500 mbar
-1	Opening pressure p_d 10-150 mbar
-2	Opening pressure p_d 151-340 mbar
Z	Special adjusting range

6 Project planning information

6.1 Installation

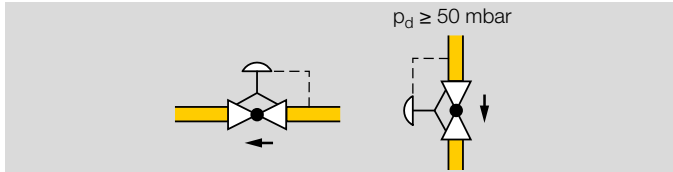

Installation position: spring dome in the vertical upright position, not upside down.

With opening pressures of > 50 mbar: spring dome in the vertical upright position or tilted up to the horizontal, not upside down.

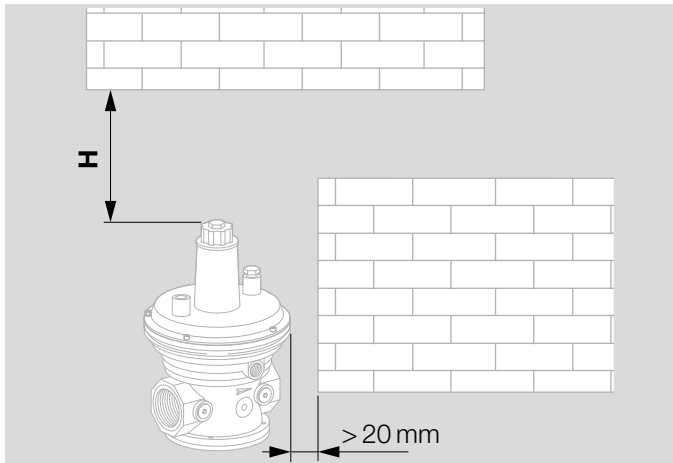

The VAR must not be in contact with masonry. Minimum clearance 20 mm. Ensure that there is sufficient space for installation and for changing the spring **H**:

Type	Distance H [mm]
VAR 15	120
VAR 25, VAR 40	180
VAR 50	200
VAR 65, VAR 80	320
VAR 100, VAR 150	360

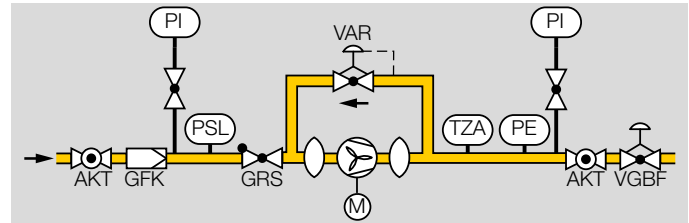

The use of bellows units or flexible tubes (A) allows for the installation in pipelines under little mechanical stress and reduces the transmission of vibrations.

Sealing material and dirt, e.g. thread cuttings, must not be allowed to get into the regulator housing.

Install a filter upstream of every system.

Do not store or install the unit in the open air.

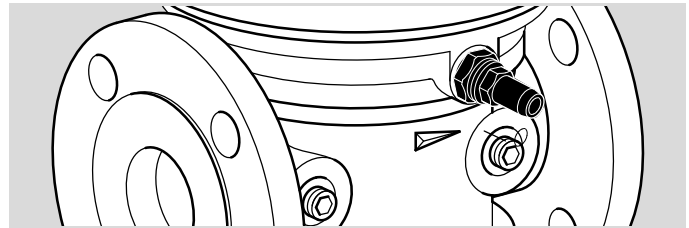

The unit is delivered with a test nipple fitted to the side to measure the inlet pressure p_u or opening pressure p_{as} .

Circulation pressure control and relief regulators must be designed as small as possible to maintain good control

Project planning information

characteristics see page 7 (Flow rate). It may be necessary to expand the pipeline to avoid flow velocities of ≥ 30 m/s in pipelines.

7 Technical data

Gas types: town gas, natural gas, LPG (gaseous) and bio-gas (max. 0.02 %-by-vol. H₂S). The gas must be dry in all temperature conditions and must not contain condensate.

Inlet pressure $p_{u \max}$: 500 mbar.

Ambient temperature: -15 to +60°C.

Internal thread: Rp to ISO 7-1.

Flanged connection: PN 16 to ISO 7005.

Housing: aluminium,
diaphragms: Perbunan,
valve seat: aluminium,
valve stem: aluminium,
valve plate: Perbunan.

7.1 Spring table

The opening pressure p_{as} is adjusted by inserting different springs.

Opening pressure range p [mbar]	Marking	Order No.				
		VAR 25, VAR 40	VAR 50	VAR 65	VAR 80	VAR 100
10–25	red	75421971	75422041	75426170	75426240	75426320
26–40	yellow	75421980	75422051	75426180	75426250	75426330
41–55	green	75421990	75422061	75426190	75426260	75426340
56–70	blue	75422000	75422071	75426200	75426270	75426350
71–85	black	75422010	75422081	75426210	75426280	75426360
86–100	white	75422020	75422091	75426220	75426290	75426370
101–150	black/red	75438978	75438981	75446329	75438984	75438987
151–220	black/yellow	75438979	75438982	–	75438985	75438988
221–340	black/green	75438980	75438983	–	75438986	75438989

Dispatch complete with label for changed outlet pressure

p_{as} .

7.2 Dimensions

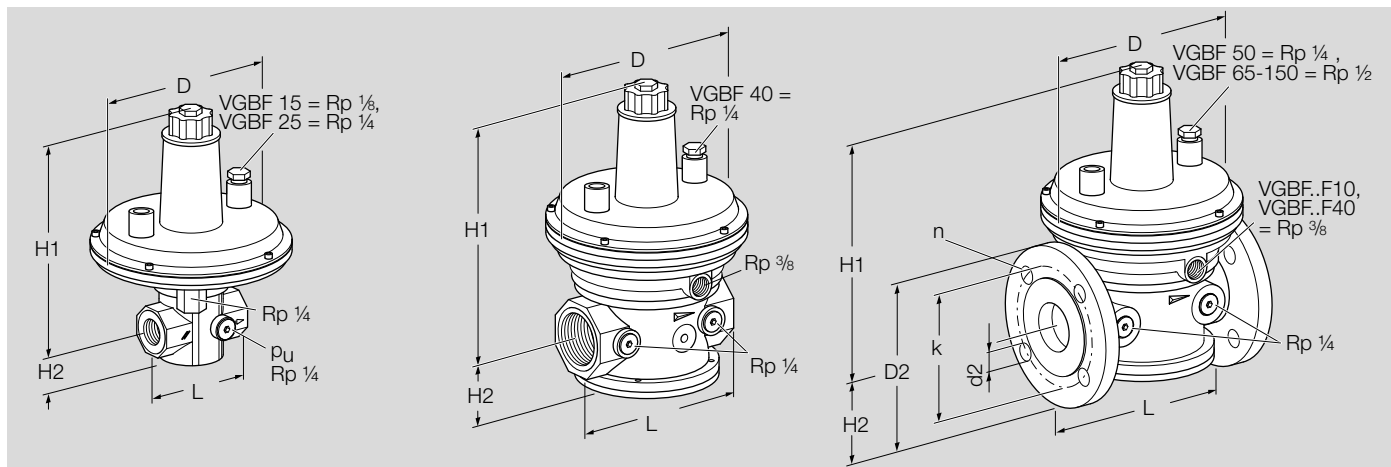

VAR 25R; VAR 40R; VAR 40-150F

Type	DN	Connection	L [mm]	H1 [mm]	H2 [mm]	D [mm]	$p_{u \max}$ [mbar]	D2 [mm]	k [mm]	d2 [mm]	n Number	Weight [kg]
VAR 25R	25	Rp 1	90	250	33	190	500	–	–	–	–	1.9
VAR 40R	40	Rp 1½	150	260	56	190	500	–	–	–	–	2.9
VAR 40F	40	40	200	260	75	190	500	150	110	18	4	4.8
VAR 50F	50	50	230	316	83	240	500	165	125	18	4	7.7
VAR 65F	65	65	290	412	89	260	500	185	145	18	4	12.0
VAR 80F	80	80	310	446	100	310	500	200	160	18	8	16.1
VAR 100F	100	100	350	501	115	396	500	229	180	18	8	26.0

8 Maintenance cycles

At least once a year, at least twice a year in the case of biologically produced methane.

Fore more information

The Honeywell Thermal Solutions family of products includes Honeywell Combustion Safety, Eclipse, Exothermics, Hauck, Kromschroder and Maxon. To learn more about our products, visit ThermalSolutions.honeywell.com or contact your Honeywell Sales Engineer.

Elster GmbH
Strotheweg 1, D-49504 Lotte
T +49 541 1214-0
hts.lotte@honeywell.com
www.kromschroeder.com

© 2019 Elster GmbH

We reserve the right to make technical modifications in the interests of progress.

